

# CURVA 45°

BEND 45°

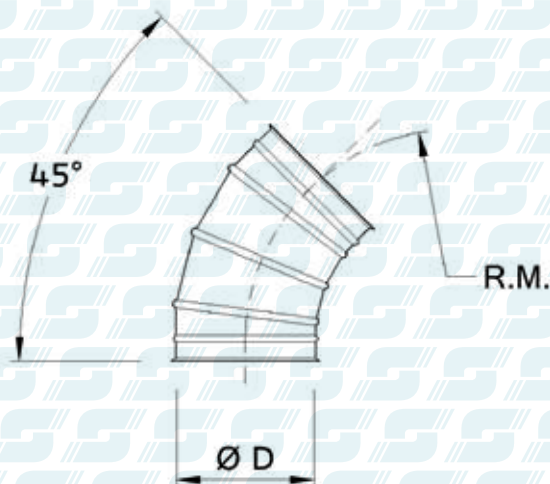

Cod. Art.	ØD [mm]	Gradi Deg.	R.M. M.R.	Sp./Thk [mm]	Prezzo €
CR45-0080	80	45°	120	0,6	
CR45-0100	100	45°	150	0,6	
CR45-0120	120	45°	180	0,6	
CR45-0140	140	45°	210	0,6	
CR45-0150	150	45°	225	0,6	
CR45-0160	160	45°	240	0,6	
CR45-0180	180	45°	270	0,6	
CR45-0200	200	45°	300	0,6	
CR45-0220	220	45°	330	0,6	
CR45-0240	240	45°	360	0,6	
CR45-0250	250	45°	375	0,6	
CR45-0260	260	45°	390	0,6	
CR45-0280	280	45°	420	0,6	
CR45-0300	300	45°	375	0,8	
CR45-0320	320	45°	400	0,8	
CR45-0340	340	45°	425	0,8	
CR45-0350	350	45°	438	0,8	
CR45-0360	360	45°	450	0,8	
CR45-0380	380	45°	475	0,8	
CR45-0400	400	45°	500	0,8	
CR45-0420	420	45°	525	0,8	
CR45-0440	440	45°	550	0,8	
CR45-0450	450	45°	563	0,8	
CR45-0460	460	45°	575	0,8	
CR45-0480	480	45°	600	0,8	
CR45-0500	500	45°	500	0,8	
CR45-0520	520	45°	520	0,8	
CR45-0540	540	45°	540	0,8	

Cod. Art.	ØD [mm]	Gradi Deg.	R.M. M.R.	Sp./Thk [mm]	Prezzo €
CR45-0550	550	45°	550	0,8	
CR45-0560	560	45°	560	1,0	
CR45-0580	580	45°	580	1,0	
CR45-0600	600	45°	600	1,0	
CR45-0620	620	45°	620	1,0	
CR45-0640	640	45°	640	1,0	
CR45-0650	650	45°	650	1,0	
CR45-0660	660	45°	660	1,0	
CR45-0680	680	45°	680	1,0	
CR45-0700	700	45°	700	1,0	
CR45-0720	720	45°	720	1,0	
CR45-0740	740	45°	740	1,0	
CR45-0750	750	45°	750	1,0	
CR45-0760	760	45°	760	1,0	
CR45-0780	780	45°	780	1,0	
CR45-0800	800	45°	800	1,0	
CR45-0820	820	45°	820	1,0	
CR45-0840	840	45°	840	1,0	
CR45-0850	850	45°	850	1,0	
CR45-0860	860	45°	860	1,0	
CR45-0880	880	45°	880	1,0	
CR45-0900	900	45°	900	1,0	
CR45-0920	920	45°	920	1,0	
CR45-0940	940	45°	940	1,0	
CR45-0950	950	45°	950	1,0	
CR45-0960	960	45°	960	1,0	
CR45-0980	980	45°	980	1,0	
CR45-1000	1000	45°	1000	1,0	

Su richiesta si eseguono diametri, spessori e materiali diversi.

Il prodotto può essere realizzato in 4 versioni: • bordo anello • bordo manicotto • liscio • flangiato (con aggiunta costo flangia).

On request other diameters, thicknesses and materials are available.

The product can be produced in 4 different versions: • ring edge • sleeve edge • smooth • flanged (with flange cost supplement).